



## 消防泵机组设备 Fire pump Equipment



湖南南方安美消防设备有限公司  
CNP NM FIRE FIGHTING SYSTEM CO., LTD





## 公司简介

湖南南方安美消防设备有限公司（以下简称“南方安美”）是由南方中金环境股份有限公司控股的企业。公司位于湖南省长沙经济技术开发区，主要以生产、销售符合国内、国际标准且具有相关国内、国际消防认证的柴油机消防泵组、电动机消防泵组、电气控制设备以及消防泵等。公司为NFPA国际消防协会会员企业，拥有一支具备二十多年全球领域消防设备研发经验的团队，其中包括多名外籍工程师及专家，现多种水泵、柴油机型号产品已取得美国UL、FM、法国APSAD、新加坡SETSCO认证及中国CCCF认证。

公司以保障社会消防安全为己任，本着“诚信、共赢”的精神，愿为广大客户提供高质量、高性价比的产品和便捷、优质的服务。



## 一流的产品生产设备与场地 First-class production equipment and workshop



## Company Profile

CNP NM Fire Fighting System Co.,Ltd (Hereinafter referred to as NM FIRE), the subsidiary of Nanfang Zhongjin Environment Co.,Ltd, is currently the first domestic pump enterprise which have got UL、FM (America) and CCCF (China) certificates. NM FIRE is located in Economic and Technological Development Zone of Changsha, Hunan province, mainly produce and sell Diesel engine & Motor driven fire pump groups, controllers and fire pumps which are in accordance with domestic & international standards and have gotten related certifications. NM Fire is the member enterprise of NFPA, the technical team consists of a number of engineers and foreign experts who have more than 20 years of experience in research and development for global fire - fighting equipments. There are several models have gotten UL,FM (America), APSAD(France), SETSCO (Singapore)、CCCF(China) certificates.

NM Fire is to protect the community fire safety, in line with the spirits of “integrity, win-win” , glad to provide high cost-effective products and high-quality service for our customer.



一流的国际技术标准产品  
First-class products that meet international technical standards

## CERTIFICATE OF COMPLIANCE

**Certificate Number** 20180308-EX26748  
**Report Reference** EX26748-20160825  
**Issue Date** 2018-MARCH-08

**Issued to:** CNP NM FIRE FIGHTING SYSTEM CO LTD  
Factory Area of CNP Changsha Co Ltd  
No.45 Xi Chong Road  
Quan Tang Street, Changsha ETDZ  
Changsha, Hunan 410100 CHINA

**This is to certify that  
representative samples of**

CENTRIFUGAL FIRE PUMPS, SPLIT CASE  
Centrifugal Fire Pumps, Split Case:-  
Model Designation:-SCF125-80-350G, SCF150-100-320,  
SCF150-100-320, SCF200-125-300, SCF200-125-380,  
SCF200-150-460, SCF200-150-460, SCF250-200-350,  
SCF250-200-350, SCF250-200-430, SCF250-200-430,  
SCF250-200-430, SCF300-250-490, SCF300-250-490,  
SCF300-250-490.

Have been investigated by UL in accordance with the  
Standard(s) indicated on this Certificate.

**Standard(s) for Safety:** UL448 Standard for Centrifugal Fire Pumps for Fire  
Protection Service  
ULC/ORD-C448 Standard for Guide for the Investigation of  
Pumps for Fire Protection Service

**Additional Information:** See the UL Online Certifications Directory at  
[www.ul.com/database](http://www.ul.com/database) for additional information

Only those products bearing the UL Certification Mark should be considered as being covered by UL's  
Certification and Follow-Up Service.

Look for the UL Certification Mark on the product.

  
Bruce Mahrenholz, Director North American Certification Program  
UL LLC

Any information and documentation involving UL Mark services are provided on behalf of UL LLC (UL) or any authorized licensee of UL. For questions, please  
contact a local UL Customer Service Representative at <http://ul.com/aboutus/localoffice>



Page 1 of 1





# CERTIFICATE OF COMPLIANCE

**Certificate Number** 20171211- EX27431  
**Report Reference** EX27431-20170728  
**Issue Date** 2017-DECEMBER-11

**Issued to:** CNP NM FIRE FIGHTING SYSTEM CO LTD  
Factory Area of CNP Changsha Co Ltd, No.45 Xi Chong Road, Quan Tang Street, Changsha ETDZ, Changsha Hunan 410100 CHINA

**This is to certify that representative samples of** CENTRIFUGAL FIRE PUMPS, END SUCTION  
Centrifugal Fire Pumps, End Suction, Single Stage.  
All models are intended for installation with the shaft in the horizontal position.  
Models: ESF 50/26, ESF 50/26, ESF 65/26, ESF 65/26, ESF 65/26, ESF 65/26, ESF 80/26, ESF 80/26, ESF 50/20, ESF 50/20, ESF 50/20, ESF 50/20, ESF 65/20, ESF 65/20, ESF 65/20, ESF 65/20, ESF 65/20, ESF 65/20, ESF 65/20, ESF 65/20, ESF 65/20, ESF 65/20, ESF 65/20, ESF 65/20, ESF 80/20, ESF 80/20, ESF 80/20.

Have been investigated by UL in accordance with the Standard(s) indicated on this Certificate.

**Standard(s) for Safety:** UL 448 - Pumps for Fire-Protection Service  
ULC/ORD-C448 - Guide for the Investigation of Pumps for Fire Protection Service

**Additional Information:** See the UL Online Certifications Directory at [www.ul.com/database](http://www.ul.com/database) for additional information

Only those products bearing the UL Certification Mark should be considered as being covered by UL's Certification and Follow-Up Service.

Look for the UL Certification Mark on the product.

*B. Mahholz*

Bruce Mahrenzholz, Director North American Certification Program  
UL LLC

Any information and documentation involving UL Mark services are provided on behalf of UL LLC (UL) or any authorized licensee of UL. For questions, please contact a local UL Customer Service Representative at [http://ul.com/about/localinfo](mailto:info@ul.com)





一流的国际技术标准产品  
First – class international technical standards

## CERTIFICATE OF COMPLIANCE

Certificate Number 20171214-EX26721  
Report Reference EX26721-20171212  
Issue Date 2017-DECEMBER-14

Issued to: CNP NM FIRE FIGHTING SYSTEM CO LTD  
Factory Area of CNP Changsha Co Ltd  
No.45 Xi Chong Road  
Quan Tang Street, Changsha ETDZ  
Changsha, Hunan 410100 CHINA

This is to certify that representative samples of INTERNAL-COMBUSTION ENGINES FOR DRIVING STATIONARY FIRE PUMPS  
Diesel engines for driving stationary fire pumps, models NM6-114, NM6-128

Have been investigated by UL in accordance with the Standard(s) indicated on this Certificate.

Standard(s) for Safety: UL 1247, Diesel Engines for Driving Stationary Fire Pumps  
ULC C448A, Guide for the investigation of diesel engine for driving centrifugal fire pumps

Additional Information: See the UL Online Certifications Directory at [www.ul.com/database](http://www.ul.com/database) for additional information

Only those products bearing the UL Certification Mark should be considered as being covered by UL's Certification and Follow-Up Service.

Look for the UL Certification Mark on the product.

*B. Mahrenholz*

Bruce Mahrenholz, Director North American Certification Program

UL LLC

Any information and documentation involving UL Mark services are provided on behalf of UL LLC (UL) or any authorized licensee of UL. For questions, please contact a local UL Customer Service Representative at <http://ul.com/about/locations/>



Page 1 of 1



消防柴油机的技术十分复杂，要对普通柴油机许多专业改装才能达到消防柴油机的要求。而UL1247消防柴油机标准，就是预先设定最苛刻的条件，如果消防柴油机在这些极端工况下能够正常工作，就能够证明其高“可靠性”；

The technology of fire fighting diesel engine is so complicated that need many professional modification for normal diesel engines to meet the fire fighting requirements. UL 1247, standard for fire fighting diesel engine, setting the extreme conditions in advance and check if the fire fighting diesel engine can work properly under these conditions, so that its high reliability can be certified.





## Certificate of Compliance

This certificate is issued for the following:

### Centrifugal Fire Pumps (Axial Split-Case Type)

SCF150-100-320, SCF200-125-300, SCF200-125-380  
SCF200-150-460, SCF250-200-430, SCF300-250-490

#### Prepared for:

CNP NM Fire Fighting System Co Ltd  
No 45 Xi Chong Road  
Quan Tang Street  
Changsha 410100  
China

FM Approvals Class: 1311

Approval Identification: 3058200

Approval Granted: March 24, 2017

To verify the product continues to be Approved please refer to [www.approvalguide.com](http://www.approvalguide.com).

Said Approval is subject to satisfactory field performance, continuing Surveillance Audits, and strict conformity to the constructions as shown in the Approval Guide, an online resource of FM Approvals.

David B. Fuller  
ABP, Manager of Fire Protection  
FM Approvals  
1151 Boston-Providence Turnpike  
Norwood, MA 02062 USA

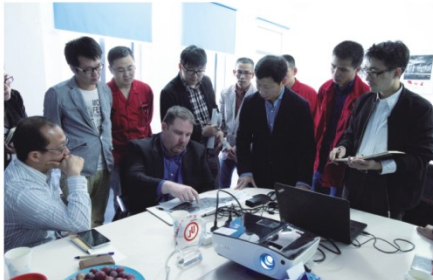

湖南南方安美消防设备有限公司是中国泵行首家美国消防协会(NFPA)的成员企业，在同时取得消防泵产品UL、FM国际消防认证之后，又取得了NFPA20系统中，技术难度最高的消防专用柴油机的UL认证，成为全球第一家取得消防专用柴油机国际消防认证的企业，打破了欧美品牌近百年来对认证产品全球市场的长期垄断。南方安美以保障人民生命财产安全为使命，致力于提升中国消防技术研究水平，按照世界一流的技术标准，制造安全、可靠的消防产品，以满足中国经济高速发展的要求，并成为“一带一路”中许多项目的首选合作伙伴。

NM FIRE is the first member of NFPA from Chinese pump manufacturers. After getting UL & FM certificates for fire pumps, UL certificate for fire fighting diesel engine, which is the most technically difficult in NFPA20 system has been gotten again. Since then, NM FIRE became the first enterprise in China which has got international fire fighting certificate for diesel engine, breaking European and American brands' hundreds years of Long-term monopoly for global listed product. NM FIRE' S mission is to protect the safety for life and property, dedicate to improve research level of fire technology in China and produce safe, reliable products in accordance with the world fist-class technical standard, to meet the requirement of rapid economic development in China and become the preferred partner in many projects of "the Belt and Road" .



**一流的产品测试检验设备**  
**First-class testing equipment**

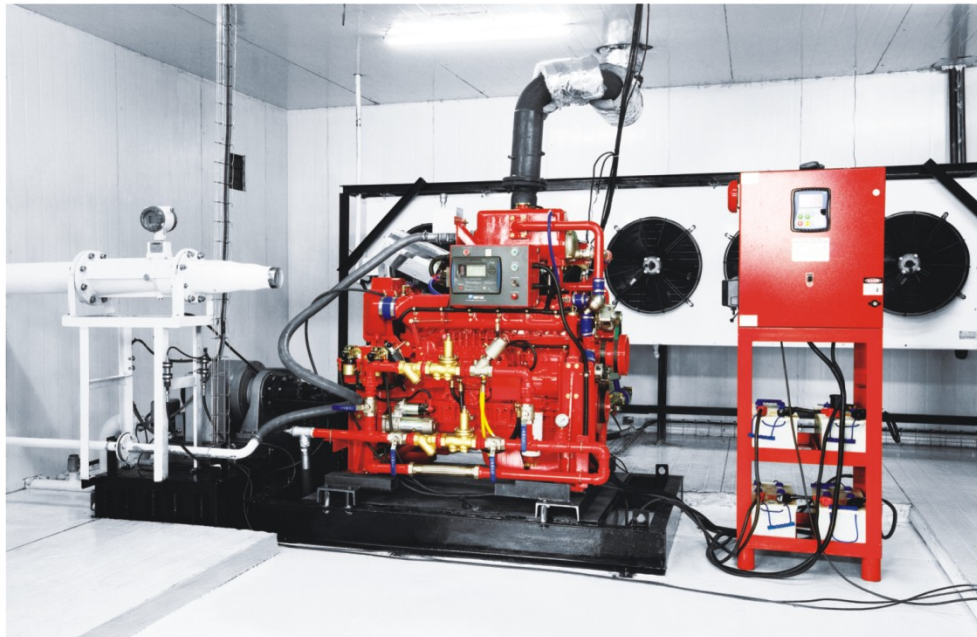

UL授予基于UL448消防泵及UL1247消防柴油机的认可目击测试实验室资质，标志着南方安美在消防泵和消防柴油机领域的实验能力提升到新的标准高度;也意味着消防泵和消防柴油机进行测试时，可在UL工程人员的辅助下，在安美自己的试验室进行相关标准的测试工作，这将显著提高产品认证效率和研发效率，对公司的产品研发和市场开拓具有重要意义。

南方安美成为全球第一家同时拥有基于UL448消防泵及UL1247消防柴油机的认可目击测试实验室资质的企业，该资质的获得充分说明了UL对南方安美消防产品研发实力的高度认可，标志着南方安美对上述相关产品的检测能力已达到国际领先水平。





## CERTIFICATE OF PARTICIPATION

Issued by  
UL LLC

### CNP NM FIRE FIGHTING SYSTEM CO LTD

No.45 Xi Chong Road Quan Tang Street, Changsha ETDZ  
Changsha, Hunan, 410100, China

to congratulate the company for having been assessed  
and found eligible to participate in the

### **-Witness Test Data Program-**

For

*UL 448, UL 448A, UL 448B, UL 448C, UL1247*

Company Party Site Number: 1122026  
Issued: April 26, 2017  
Expired: April 26, 2019

Yeo Fong  
Business Development Director  
Building, Fire & Life Safety Technologies



NM FIRE was granted the qualification of witness laboratory for both UL448 fire pump and UL1247 fire fighting diesel engine, marking that the testing ability for fire pump and fire fighting diesel engine was promoted to a new height. Meanwhile, fire pumps and diesel engine can be tested in NM FIRE'S laboratory according to some related testing standard with the assistance of UL engineers, which will improve the efficiency of both certification and R&D, and will be of great importance to company's products research and market development.

This qualification fully certified that NM FIRE'S strength in technical R&D for fire products was highly recognized by UL, it marks NM FIRE'S testing ability for above products has reached international advanced level.



一流的产品技术培训和服务  
First-class technical training and services



NM FIRE, the Chinese pump manufacturer, becomes the first member of NFPA (National Fire Protection Association) in China, jointly built “Fire Pump Technology Training Center” together with Domestic Fire Protection Association and Overseas Certificate Authority for further utilizing global advanced fire pump technology and changing backward situation of fire pump field.

The training center is currently being built. NM FIRE specially completed a standard package system for the training center in accordance with NFPA20, which can be used for on-the spot teaching and practical operation training.

Trainees:

Designers from firefighting engineering company and designing institute.

Government employees who engage in fire control management.

Fire pump dealers.

Fire pump group end uses and operators.

What can you get from training?

Operating principles of package system;

Operating procedure of package system;

Technical standard and technology training for fire pumps,

firefighting diesel engines and controllers etc;

Training for latest NFPA20 standard;

Trouble shooting in NFPA20 package system.

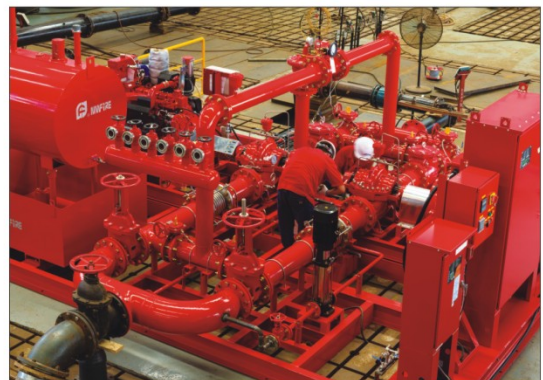



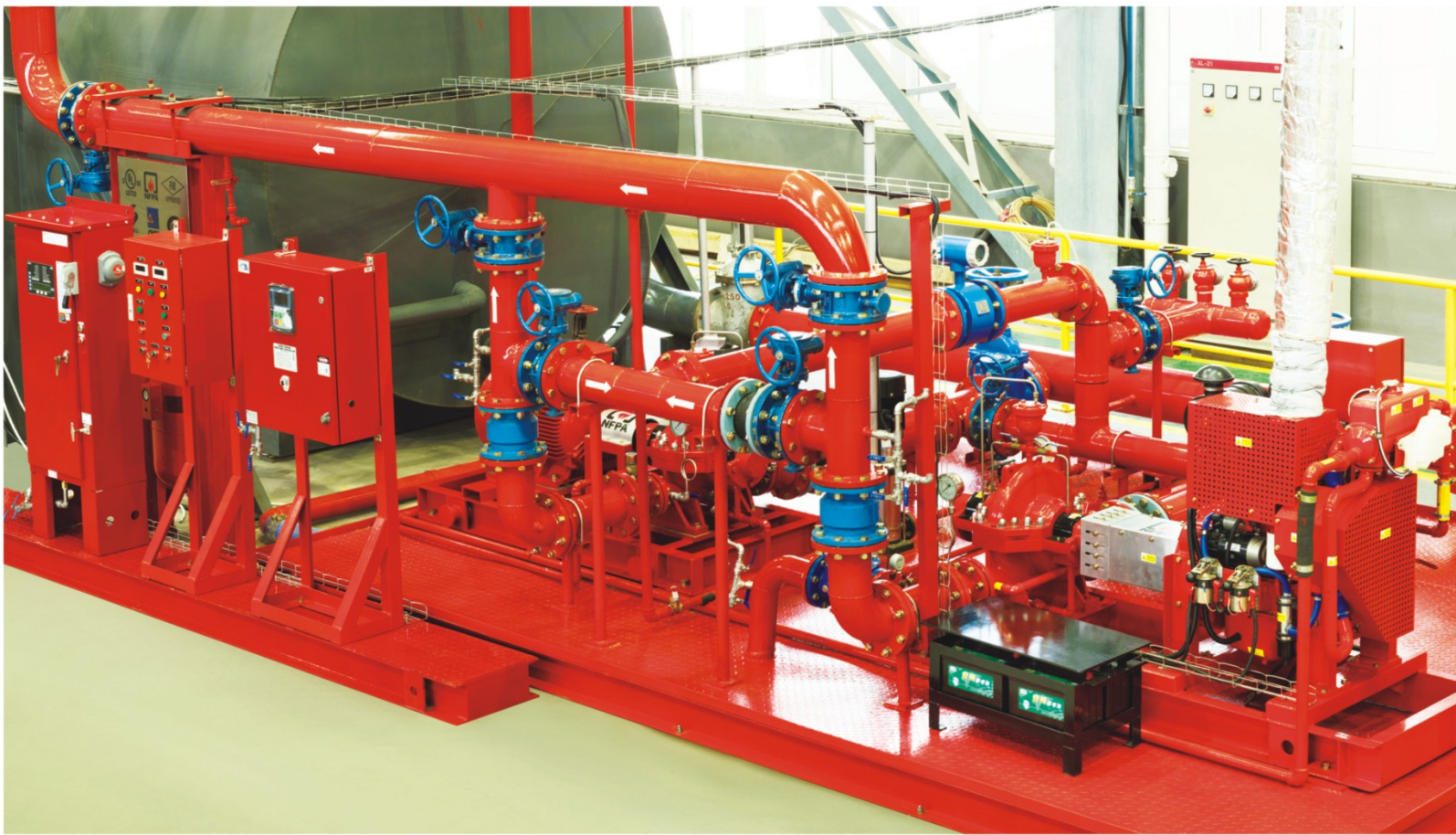

南方安美作为中国泵行业首家NFA美国消防协会会员企业，为进一步利用全球消防泵先进技术，改变中国消防泵行业落后的现状，通过与国内消防协会及国外认证机构合作，共同组建了“消防泵机组技术培训学校”；

目前学校正在筹建之中，南方安美按照NFA20标准，专门为学校建成了一套完整的NFA20消防泵撬装系统，可为学员提供现场教学演示以及实践操作培训。

#### 学员群体：

- 消防工程公司与设计院设计人员
- 政府从事消防行业管理的雇员
- 消防泵设备经销商
- 消防泵机组终端用户与操作人员

#### 能从学校培训获得什么？

- 消防泵撬装系统工作原理
- 消防泵撬装系统操作程序
- 消防泵、消防柴油机以及控制器等产品的标准与技术培训
- 最新NFA 20标准的培训
- NFA20撬装系统简单故障排除





# ***Packaged Fire Pump System***

***NM Fire delivers superior fire protection***





Production facilities to worldwide.

## 主要产品(Main Product)

消防泵撬装系统(Fire Fighting Pumps Package System)

消防泵机组(Fire Fighting Pump Set)

电动消防泵机组(Motor Driven)

柴油机消防泵机组 (Diesel Engine Driven )

柴油机应急供水泵机组(Diesel Engine Emergency Water Supply Pump Set)

消防用柴油机(Fire Fighting Diesel Engine)

电控柜(Control Panel)

消防泵机组用电控柜(For Fire Fighting)

应急供水用电控柜(For Emergency Water Supply)

### 单级双吸中开离心泵

Single Stage Double Suction Split Case Centrifugal Pump



柴油机消防泵机组 (Diesel Engine Driven)



电动消防泵机组(Motor Driven)



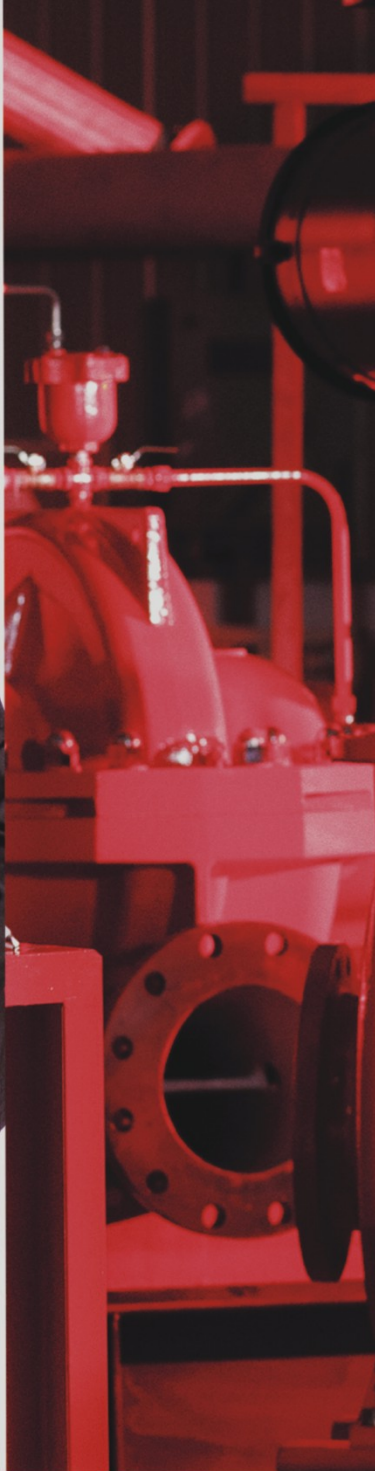



保障社会安全是消防企业的责任和使命。南方安美作为积极践行“保障人身财产安全，维护社会安全与美好”战略的UL、FM认证产品生产企业，研发团队由从事消防行业研究二十余年的法国消防专家领衔，攻克多重技术堡垒，开创了中国特色消防技术研究新局面；“路漫漫其修远兮，吾将上下而求索”，南方安美将不断打造“中国制造”的良好口碑，努力为广大客户提供高质量的产品及便捷、优质的服务，共筑安全美好的中国梦。

To protect social security is the duty and mission of fire fighting enterprise. As a manufacturer of UL&FM listed products, NM FIRE positively practise "to protect personal and property safety, maintain social security and harmony", its technical team was led by France experts who have more than 20 years of experience in fire fighting research and development, have overcome many difficulties and built new situation of professional fire fighting technology research in China.

"Way stretched endless ahead and we will search with our unbending will ." NM FIRE will continuously build good reputation for "made in China", strive to provide customers with high quality products and convenient service ,building safe and better Chinese Dream.

## 单级端吸离心泵 Single stage End Suction Centrifugal Pump



柴油消防泵机组 (Diesel Engine Driven)



电动消防泵机组 (Motor Driven)









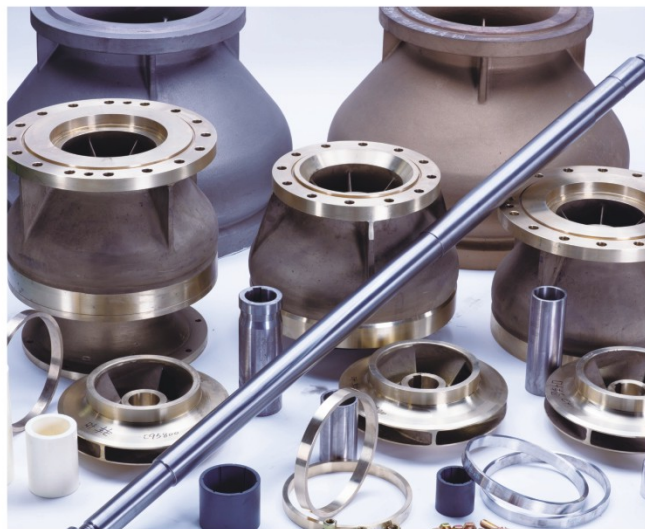

各石油、石化、化工、陆海军设计院及中石油、中石化、中海油的各油田、输油管道局、油品储备库、油品码头、工程建设公司、炼油厂、海上平台等单位。

All petroleum, petrochemical, chemical, military and naval institutes, oil fields of Petro China, Sinopec, CNOOC, pipelines Bureaus, oil repositories, oil terminals, construction companies, oil refineries, offshore platforms ,etc



可生产适合于海水消防泵用的各种材质，包括：双相不锈钢，超级双相不锈钢，镍铝青铜等。

Can supply kinds of materials for fire pumps in sea water application including Duplex Stainless Steel, Super Duplex Stainless Steel and Ni-Al Bronze.









控制柜 (Control Panel)



消防专用柴油机 (Fire fighting Diesel Engine)

消防工程公司、机场、高速公路隧道、宾馆、医院、大型超市、高档写字楼、国家级粮库、火电厂、造船厂、造纸厂、地铁站、火车站等；

Fire-Fighting Engineering Companies, airports, highway tunnels, hotels, hospitals, supermarkets, office buildings, national grain storages, thermal power plants, shipyards, paper mills, subway stations, railway stations, etc.







钢铁厂、小区住宅院、工矿企业、建材家居超市等。  
Steel plants, residential regions, industrial and mining enterprises, house building materials supermarkets, etc.



稳压泵机组 (Jockey Pump Set)



NFPA20标准消防泵撬装系统  
NFPA20 fire pumps package system

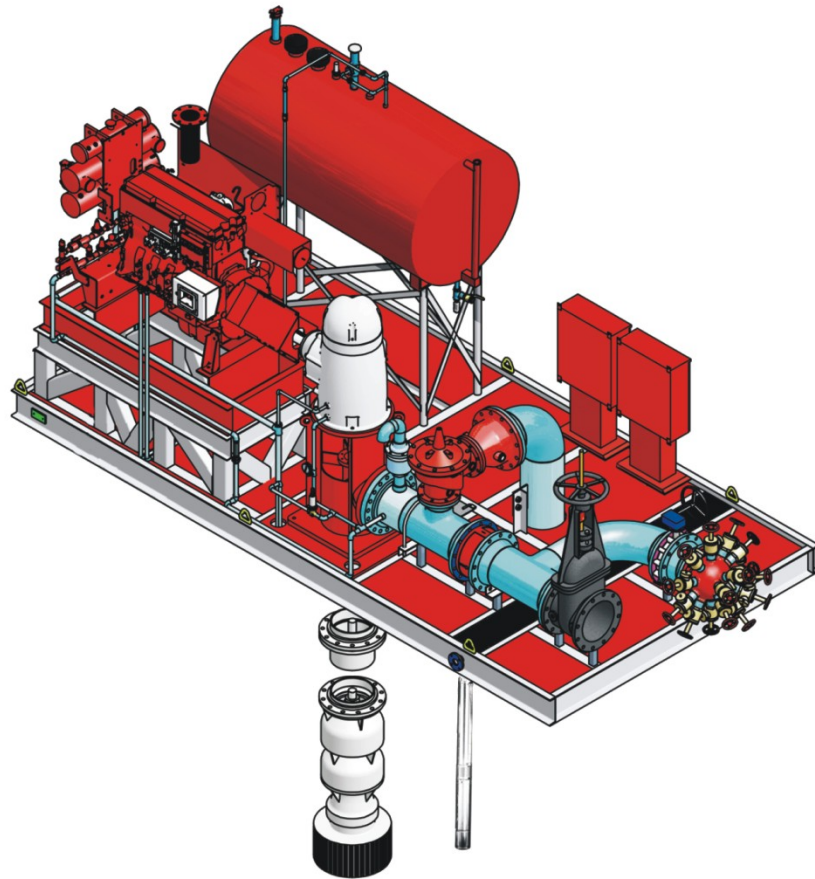
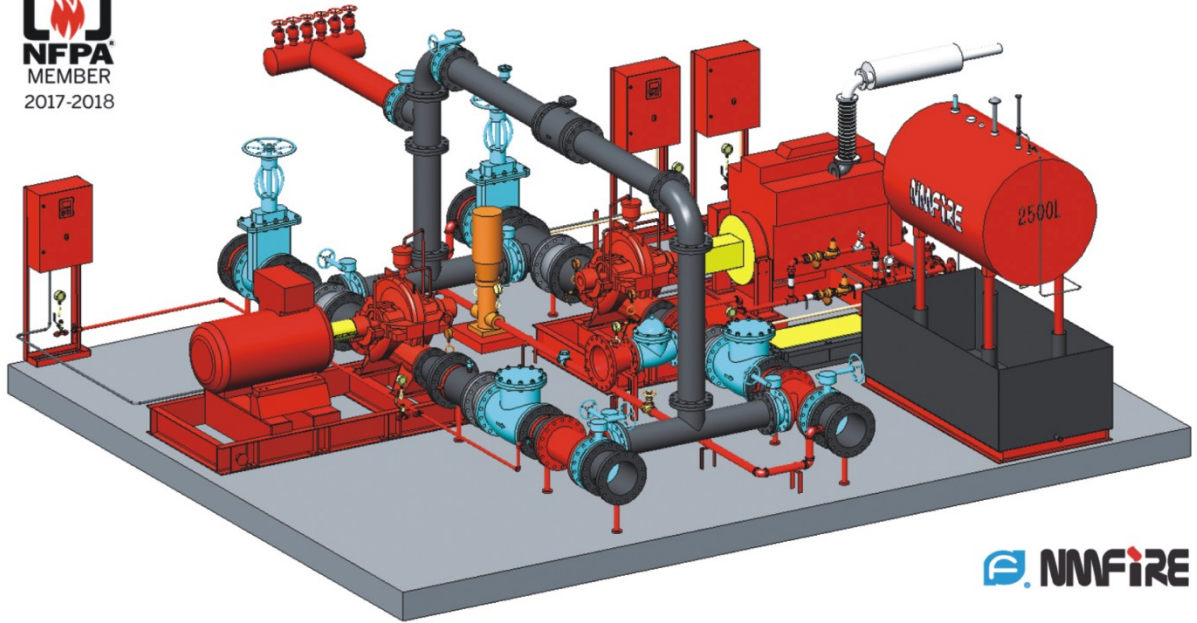



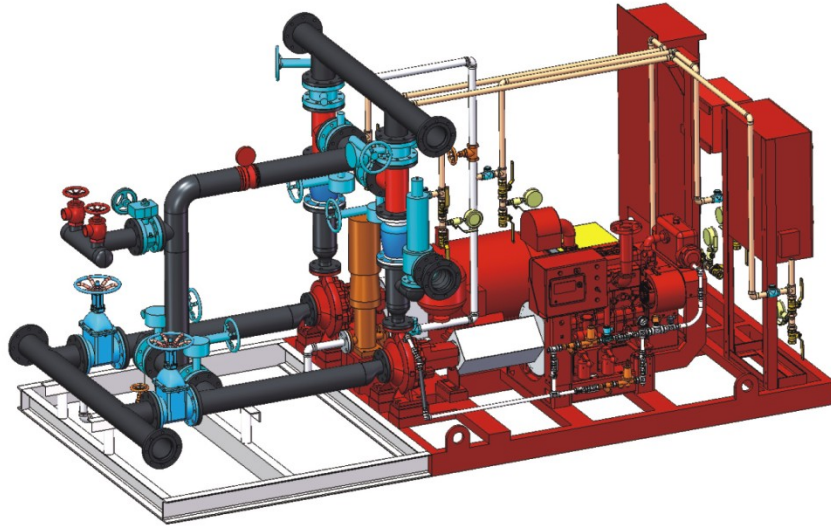

## NFPA20消防泵撬装系统简介 Introduction of NFPA20 Fire Pumps Package System

凭借多年的消防行业工作经验，南方安美现开始设计生产消防泵成套系统，该系统出厂前装配好所有必要部件，最大限度地减少用户现场工作量。

特 点：

1. 管路设计简单
2. 卖方负责全部装配
3. 符合NFPA20标准要求
4. 撬装系统在ISO9001工厂测试环境下进行严格的出厂前性能测试
5. 由于进行现场材料处理，没有材料损耗
6. 改善用户现场建设进度，节省现场安装时间
7. 现场只需进行水泵进出水口管路连接及电源接通
8. 外形设计美观

南方安美消防泵撬装系统设计适用范围包括：中开泵、端吸泵、长轴泵、立式管道泵、1台电动机和1台柴油机、2台电动机和2台柴油机配置。

With years of experience in fire protection industry, NM fire can supply fire pumps system with all necessary accessories ready for site installation, reducing amount of work on site to the greatest extent.

Advantages:

1. Simplifies piping design;
2. Single source unit responsibility;
3. A complete package that meet NFPA20 requirements;
4. Packaged systems are performance and hydrostatically factory tested at an ISO9001 certified manufacturing facility prior to shipment;
5. No material lost due to on-site material handling;
6. Improves the speed of construction and reduces on-site installation time;
7. Only external suction, discharge and power connection are required on-site;
8. State of the art engineering design.

The full range of NM FIRE solutions available includes Horizontal Split-Case, End Suction, Vertical Turbine and Vertical in-line pumps, Single Electric Motor, Single Diesel, 1 Electric motor and 1 Diesel engine, 2 Electric motors and 2 Diesel engines configurations are available.



## NFPA20 消防泵货柜泵站 NFPA20 Containerised Fire-Fighting Pump Sets



- 在现场，仅仅只需接通水和电源，机组便可马上工作。  
After simply connecting the water and power supplies on site, the unit is immediately operational.

- 先进的3D设计，严格按照NFPA20 标准要求规范设计，占地面积小。  
3D design built in a clean, controlled factory environment to a high NFPA20 engineering standard.



- 整套系统在ISO9001工厂测试环境下完成严格的系统运行及性能出厂测试。  
Fully tested at an ISO9001 manufacturing facility prior to shipment.

- 运输至现场后，只需简单的基础准备即可安装完毕。  
Once on site the containerised pump house can simply be lowered onto a prepared concrete base.





**整体式泵站、紧凑、安全、一步到位，包括：  
Integral pumps station, compact, safe,  
step in place, including:**

- 电动机驱动泵、柴油机驱动泵以及稳压泵（可根据需求选配）  
Electric driven pump、 Diesel driven pump and Jockey pump
- 电动机驱动泵、柴油机驱动泵以及稳压泵控制柜  
All the control panels
- 全套管路及阀门  
Pipework and Valves
- 燃油箱  
Fuel tank
- 照明、通风系统  
Lighting、 Air System.
- 高效的空调系统及优良的箱体保温、隔音材料  
Wall insulation reduces environment noise

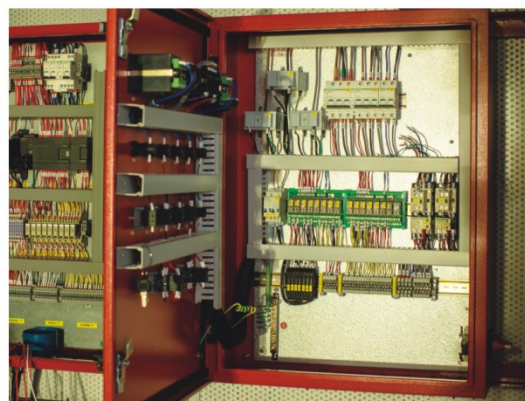



**NFPA20标准消防泵撬系统(一电、一柴、一稳压)**  
**NFPA20 Fire Pump Package System**  
**(a Electric Motor Unit & a Diesel Engine Unit & a Jockey Pump Unit)**

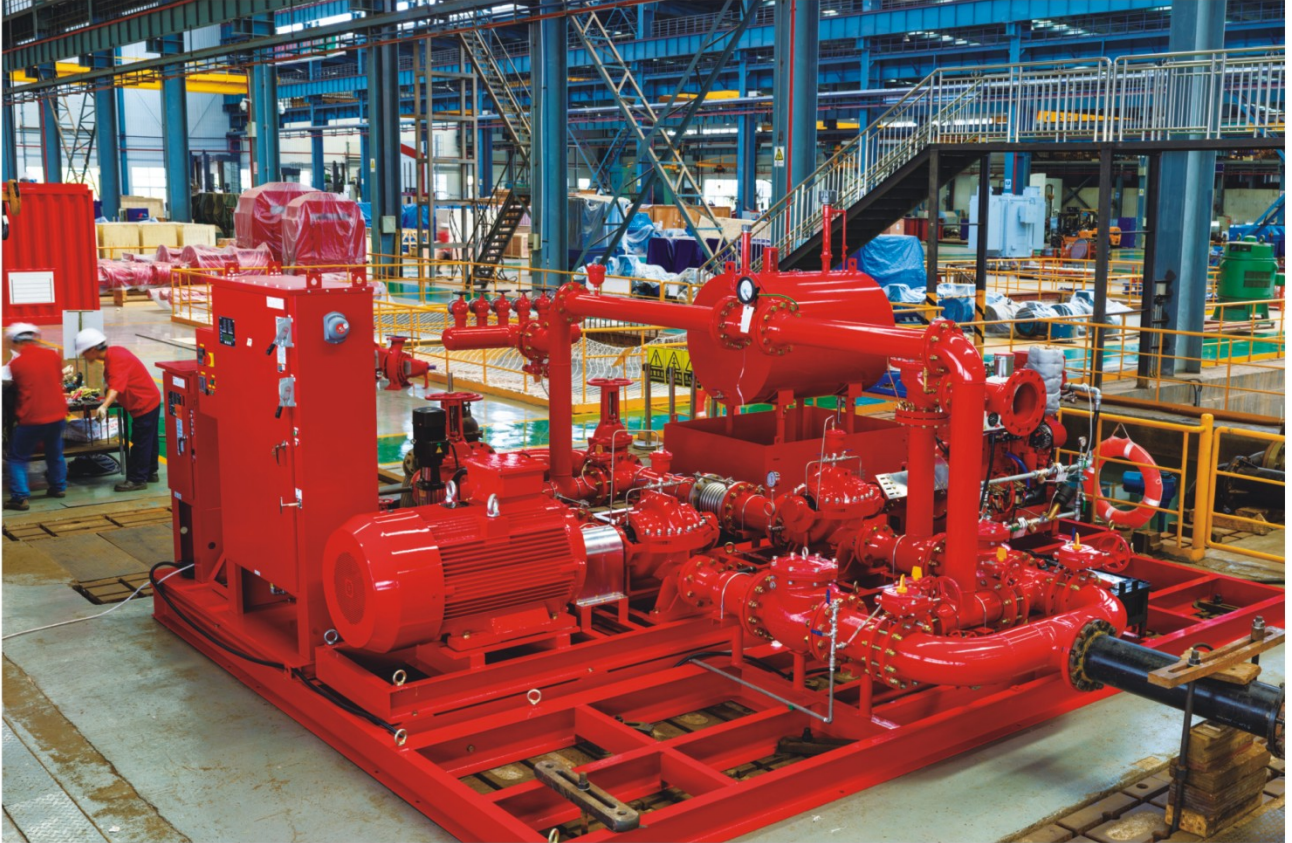



# 卧式中开离心式消防泵 Centrifugal Fire Pumps, Horizontal Split-Case Type

## UL/FM系列型号 UL/FM Model

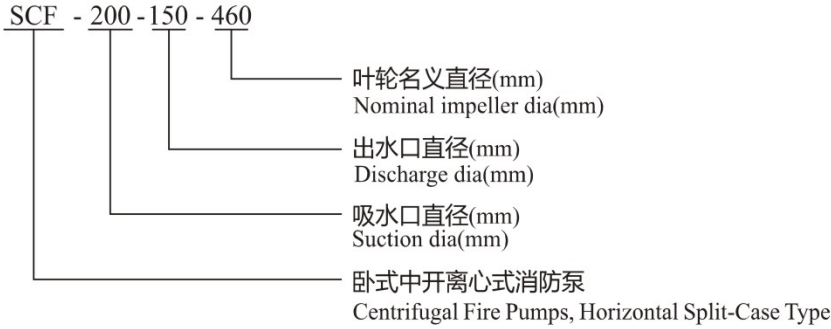

## GB系列型号 GB Model

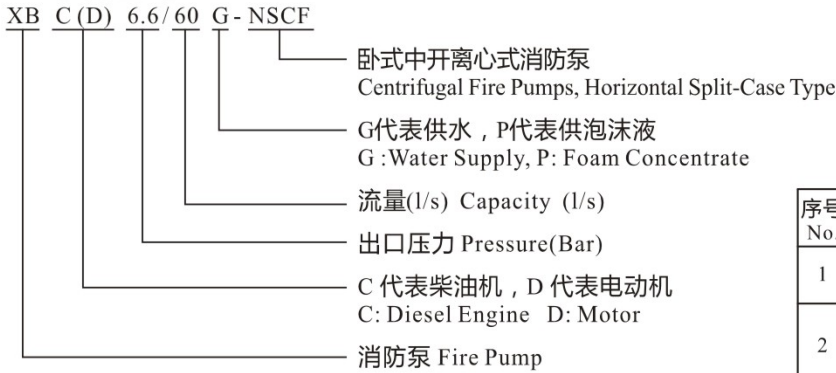

## 结构图 Structure Design

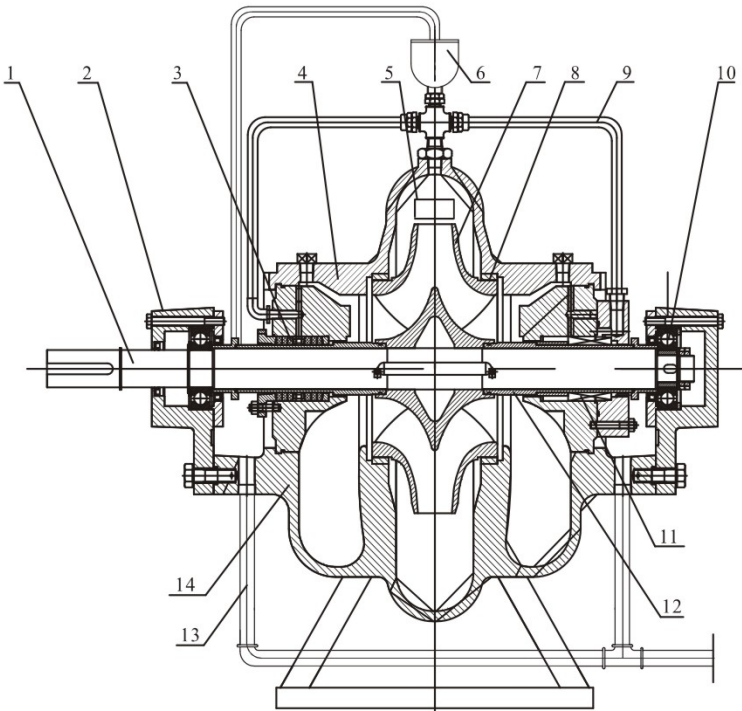

序号 No.	零 / 部件名称 Name	材质 Material
1	主轴 Shaft	20Cr13, AISI4340, S32205
2	轴承体 Bearing Housing(DE)	HT200
3	填料密封部 Packing Seal Assembly	
4	泵盖 Upper casing	QT500-7, S32205
5	铭牌 Nameplate	SS304
6	自动排气阀 Air Release Valve	
7	叶轮 Impeller	SS304, S32205
8	泵体密封环 Casing Seal Ring	C83600
9	冲洗管路 Flushing Pipe	SS304, S32205
10	轴承 Bearing	SKF
11	机械密封部 Mechanical Seal Assembly	
12	轴套 Shaft Sleeve	SS304, SS316L
13	排泄管路 Drainage Pipe	Q235B, S32205
14	泵体 Pump Casing	QT500-7, S32205



# 卧式中开离心式消防泵 Centrifugal Fire Pumps, Horizontal Split-Case Type

## UL/FM(SCF)系列卧式中开泵性能范围 UL/FM(SCF) Performance Range Of Horizontal Split-Case Type

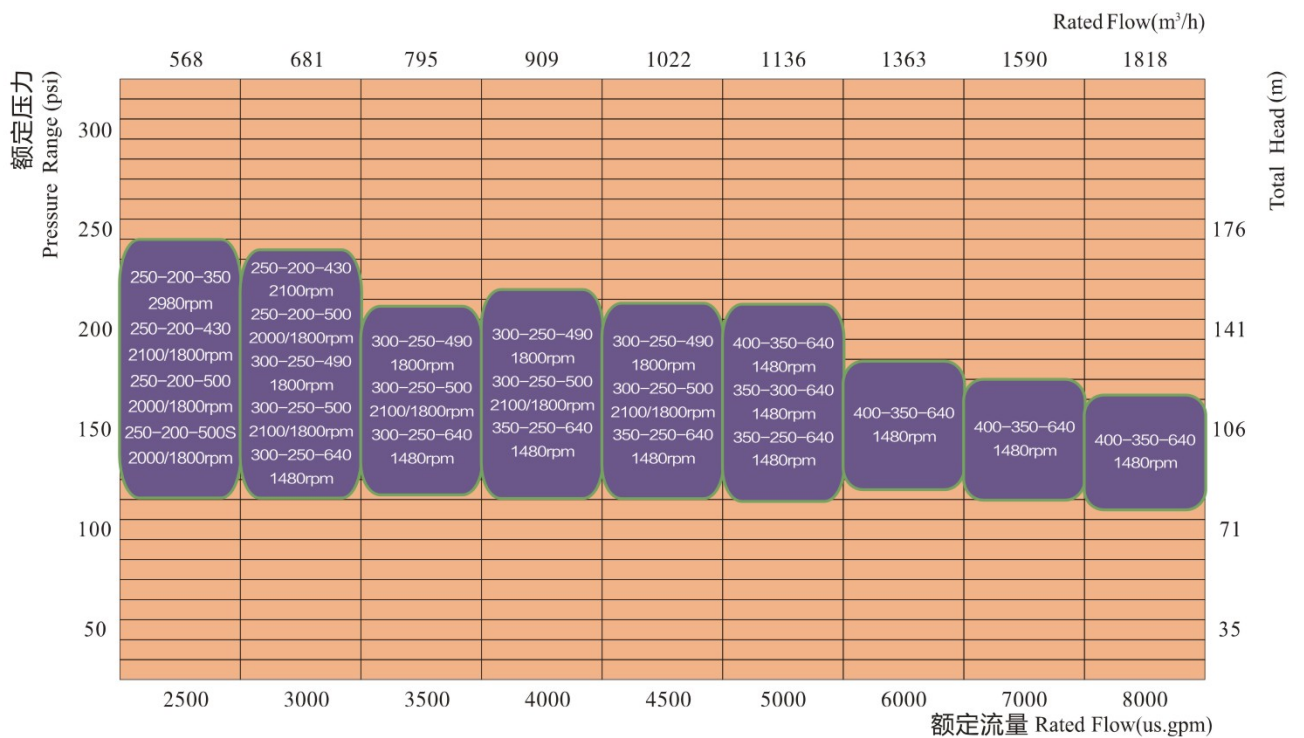
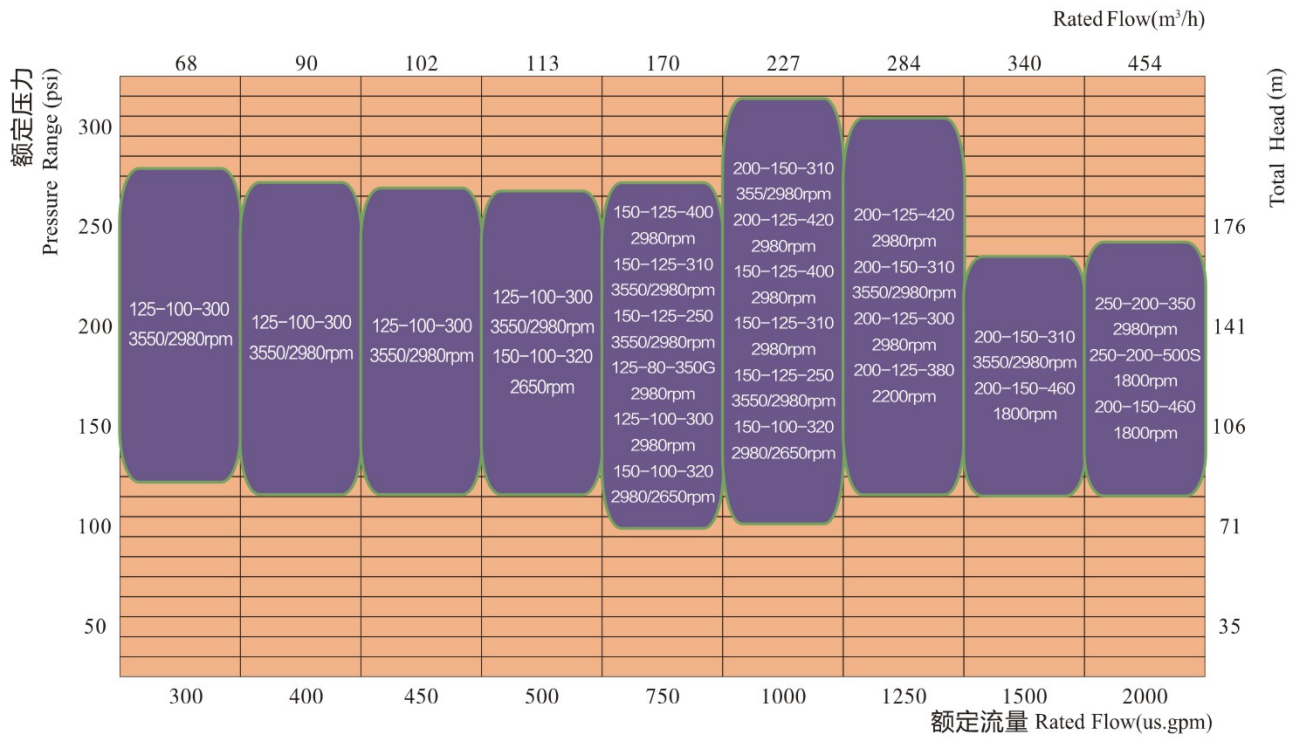



# 卧式中开离心式消防泵 Centrifugal Fire Pumps, Horizontal Split-Case Type

## GB(NSCF)系列卧式中开泵性能范围 GB(NSCF)Performance Range Of Horizontal Split-Case Type

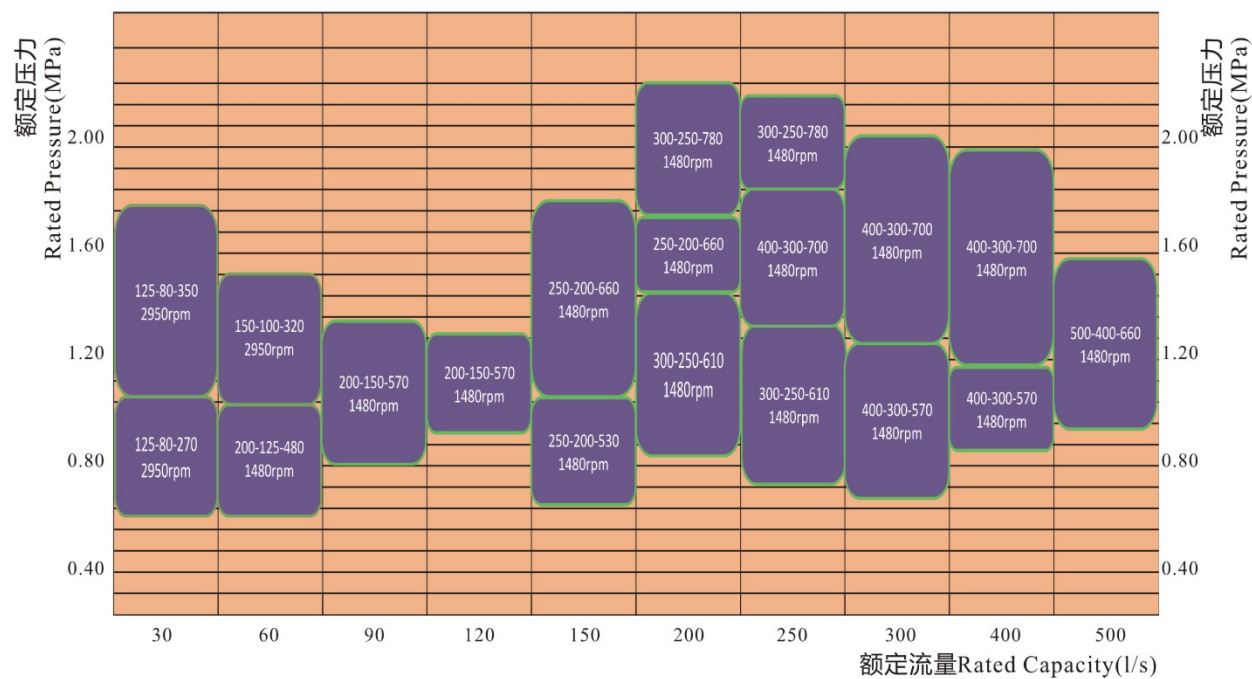
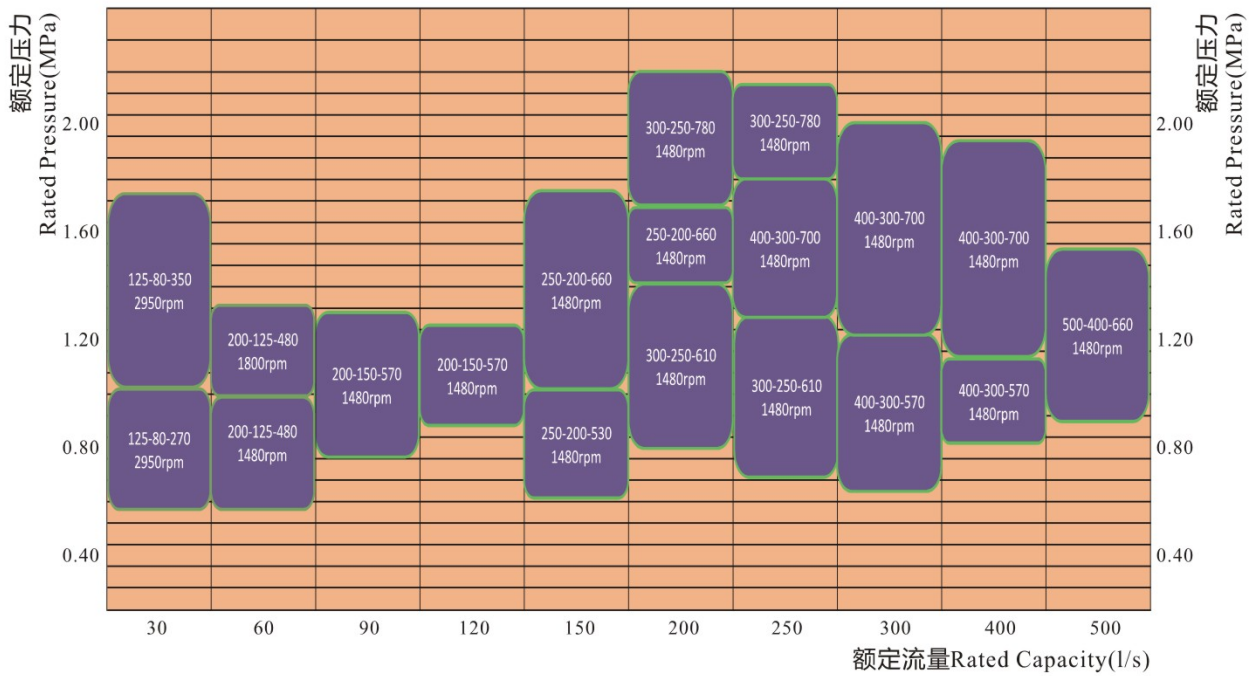



## 卧式端吸离心式消防泵组 Centrifugal Fire Pumps, Horizontal End-Suction Type

### UL/FM系列型号 UL/FM Model

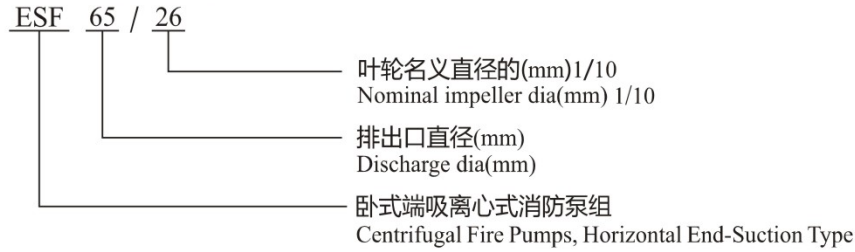

### GB系列型号 GB Model

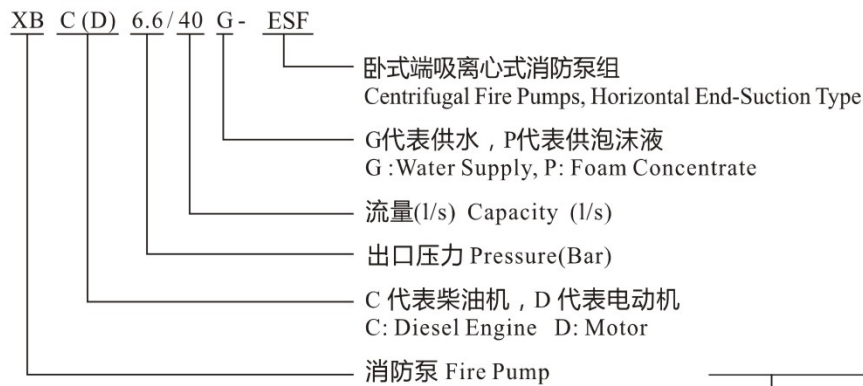

### 结构图 Structure Design

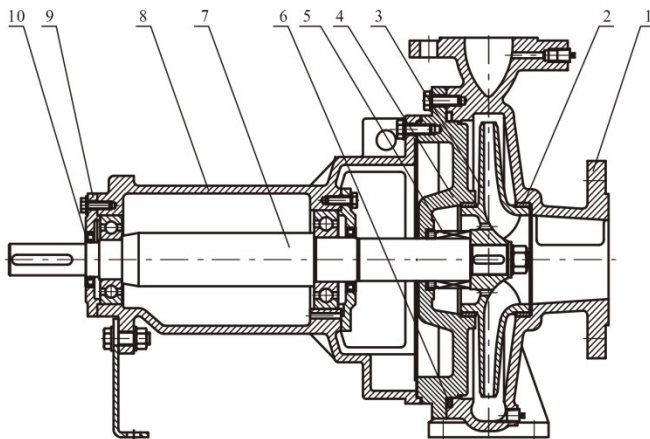

序号 NO	零件名称 Part Name	材料 Material
1	泵体 Pump Casing	QT400-18,S32205
2	耐磨环 Wear ring	C86500
3	叶轮 Impeller	C86300,S32205
4	泵盖 Upper Casing	QT400-18,S32205
5	填料密封/机械密封 Packing Seal/ Mechanical Seal	碳纤维/石墨-碳化硅 Carbon-fiber / Graphite-silicon carbide
6	O形橡胶圈 O-ring	NBR
7	泵轴 Shaft	SS420,S32205
8	悬架体 Suspension Body	HT200
9	轴承压盖 Bearing Cover	HT200
10	油封 Oil seal	NBR



**卧式端吸离心式消防泵组**  
**Centrifugal Fire Pumps, Horizontal End-Suction Type**

**端吸泵系列性能范围 ( 50Hz )**

**PERFORMANCE RANGE OF NM FIRE PUMP-END SUCTION(50Hz)**

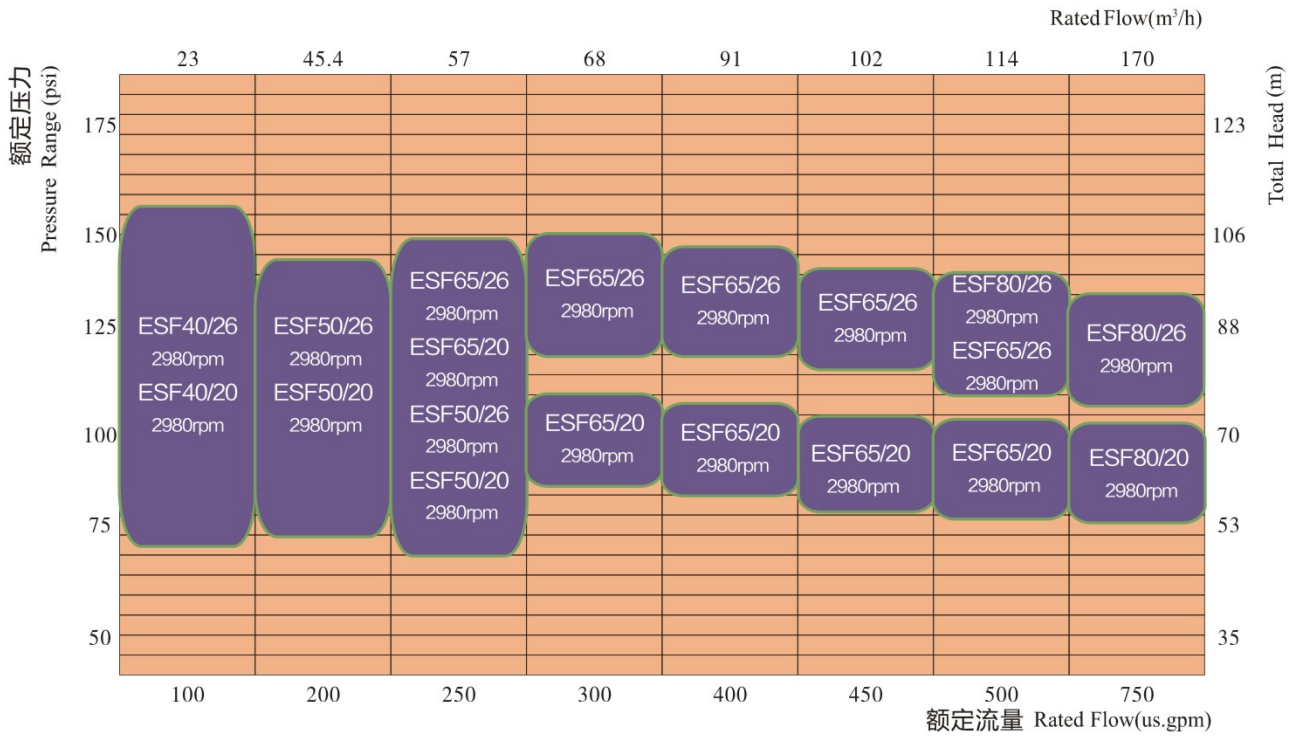

**端吸泵系列性能范围 ( 60Hz )**

**PERFORMANCE RANGE OF NM FIRE PUMP-END SUCTION(60Hz)**

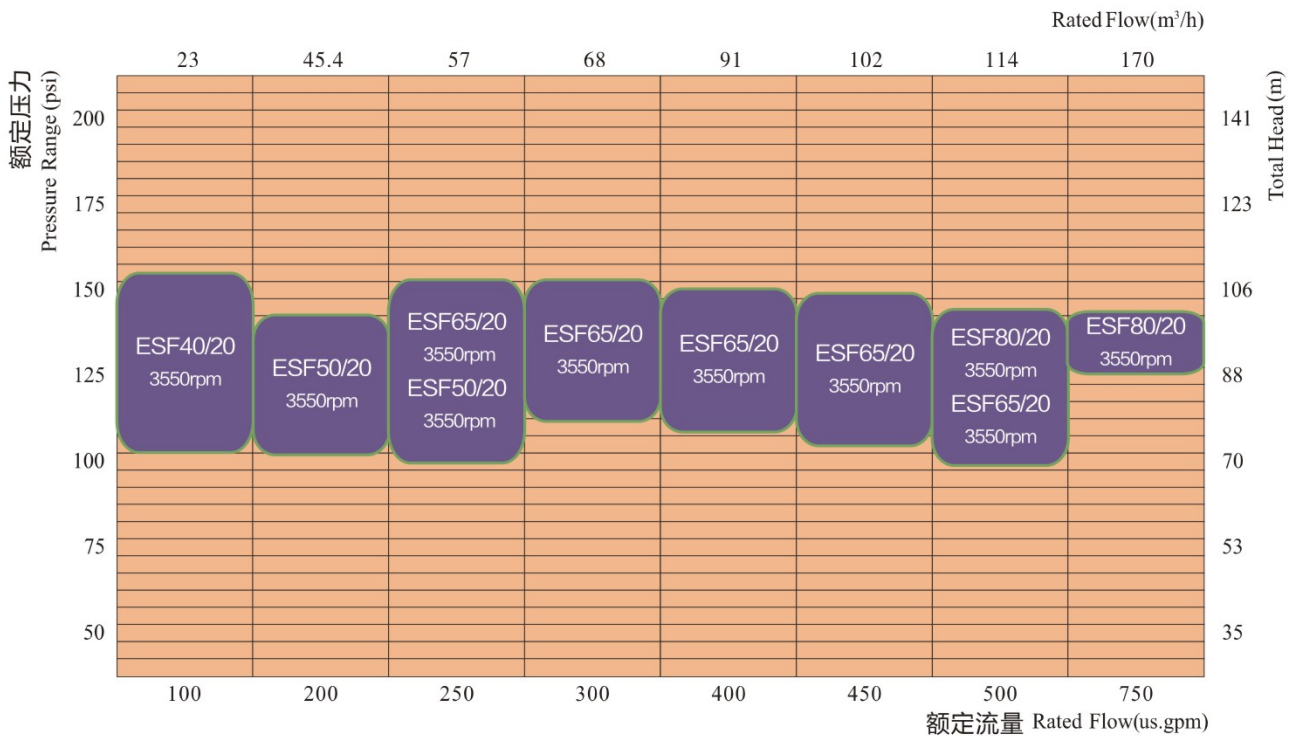



# 离心式长轴消防泵组 Centrifugal Fire Pumps, Vertical Shaft, Turbine Type

## 型号 Model

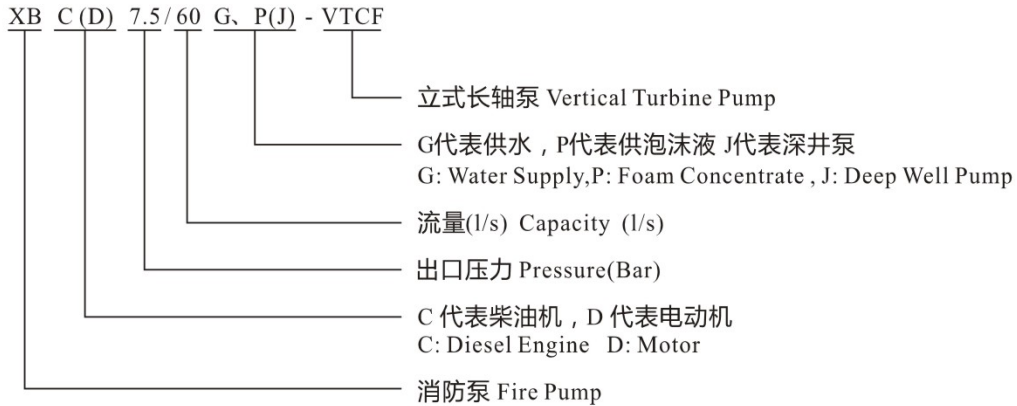

参数范围 : Specification

流量最高可达1350m<sup>3</sup>/h Capacity: Up to 1350 m<sup>3</sup>/h 扬程可达240m Head: Up to 240m

**VTCF结构图(电机)**  
Construction Drawing of VTCF(With Motor)

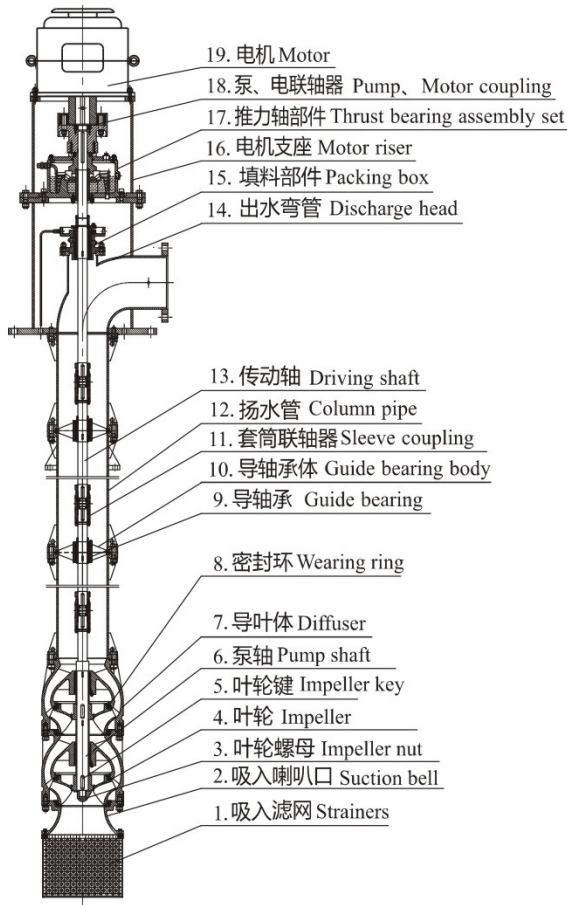

**VTCF结构图(齿轮箱)**  
Construction Drawing of VTCF(With Gear Box)

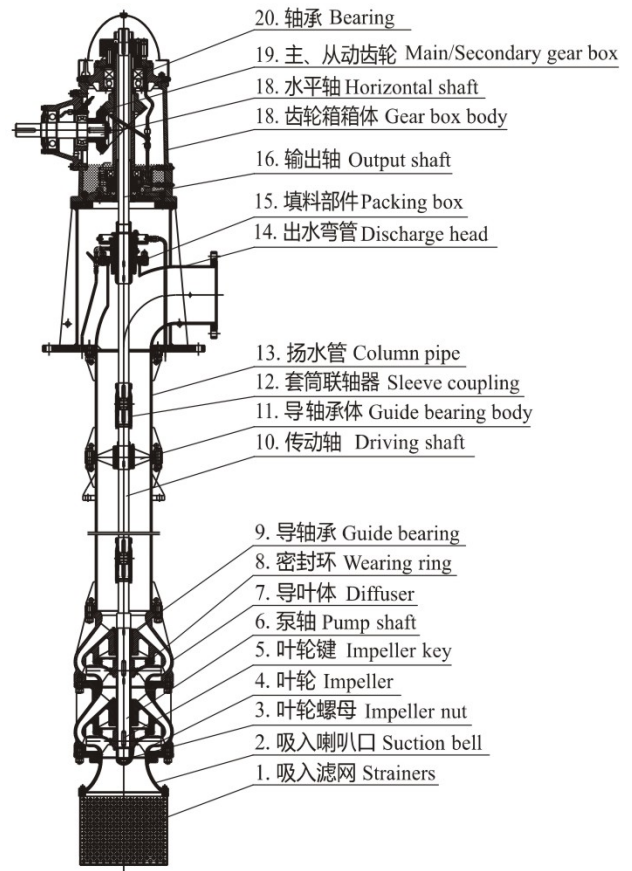



# 离心式长轴消防泵组 Centrifugal Fire Pumps, Vertical Shaft, Turbine Type

## 离心式长轴泵性能范围 Performance Range-Centrifugal Fire Pumps, Vertical Shaft Turbine Type

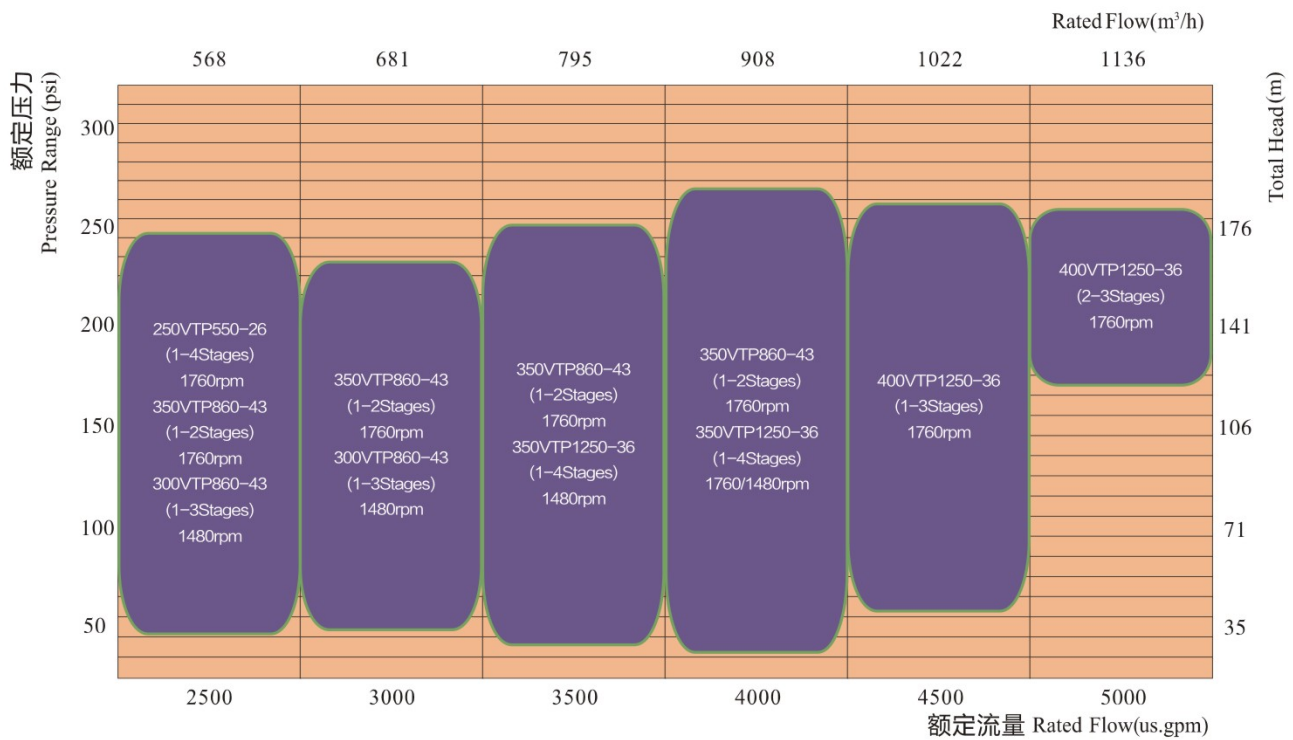
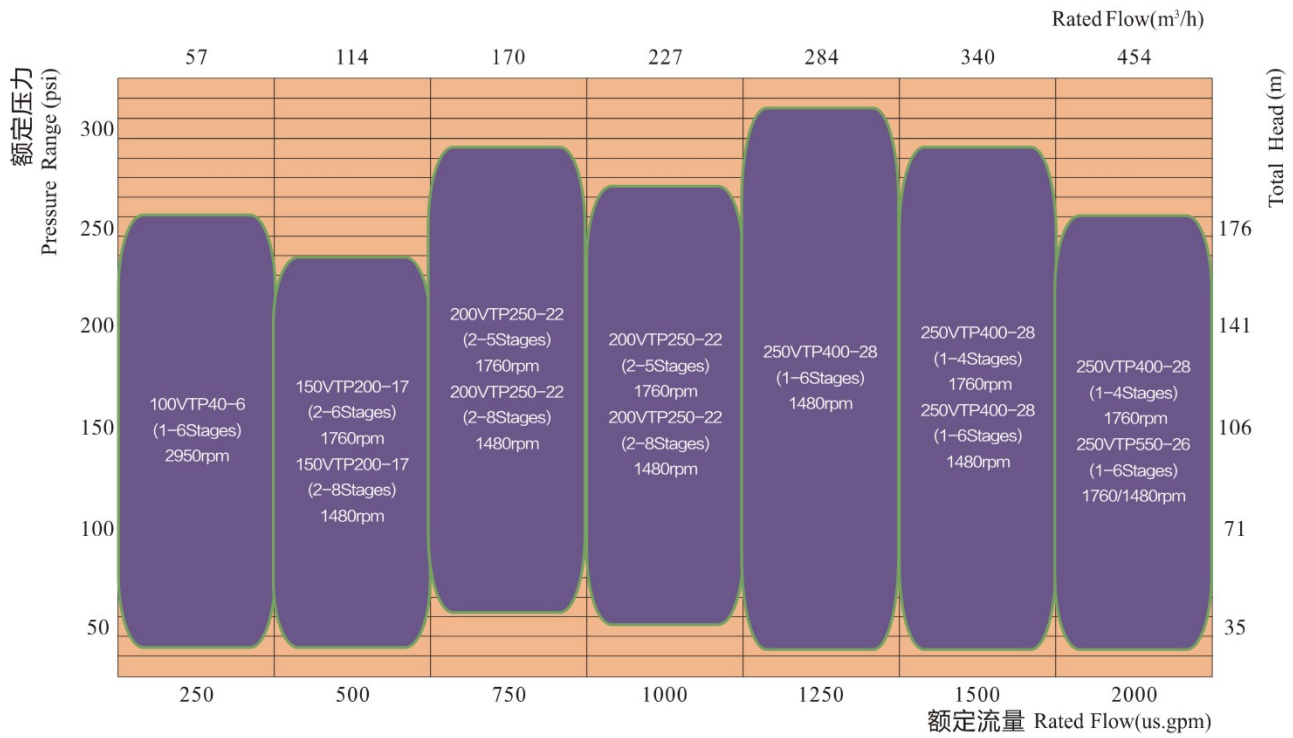



# CDLF系列不锈钢立式多级泵 (CDLF)Vertical Multistage Centrifugal pump

## 稳压给水设备

### Pressure stabilizing type water supply equipment used for fire-protection

#### 型号 Model

W 2 / 0.48 - NF

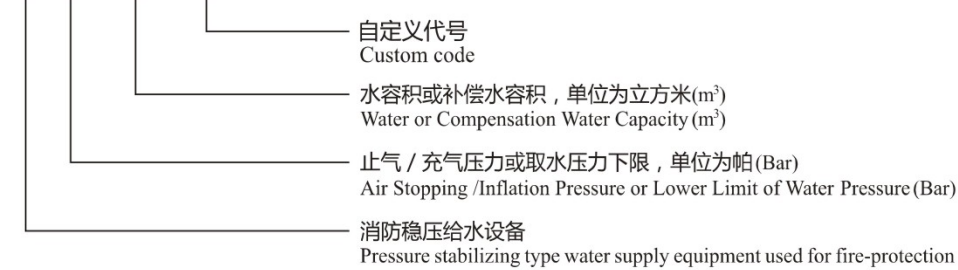

## 消防自动恒压给水设备

### Constant pressure automatic water supply equipment used for fire-protection

HBP 14 / 10 - 2 - NF

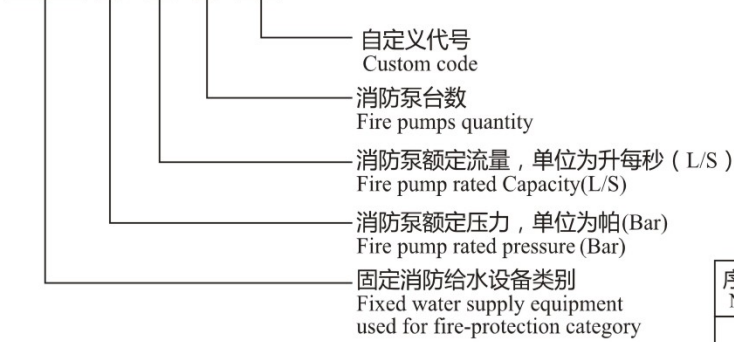

## 结构图 Structure Design

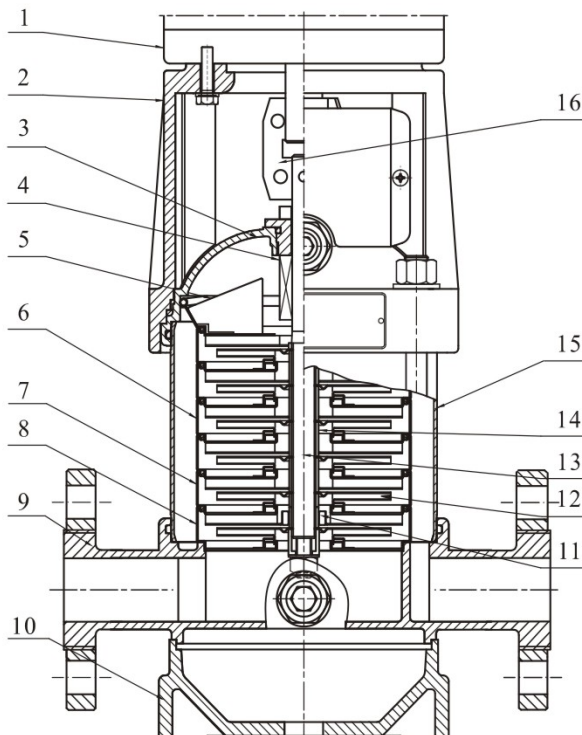

序号 No.	名称 Name	材料 Material	AISI/ASTM
1	电机 Motor		
2	泵头 Casing	铸铁 Cast iron	ASTM25B
3	泵头衬里 Seal base	不锈钢 Stainless steel	AISI304
4	机械密封 Mechanical seal		
5	出水导叶 Top diffuser	不锈钢 Stainless steel	AISI304
5	导叶 Diffuser	不锈钢 Stainless steel	AISI304
7	支撑导叶 Support diffuser	不锈钢 Stainless steel	AISI304
8	导流器 Inducer	不锈钢 Stainless steel	AISI304
9	进出水段 Inlet and outlet chamber	不锈钢 Stainless steel	AISI304
10	底座 Base plate	铸铁 Cast iron	ASTM25B
11	轴承 Bearing	碳化钨 Tungsten carbide	
12	叶轮 Impeller	不锈钢 Stainless steel	AISI304
13	轴 Shaft	不锈钢 Stainless steel	
14	叶轮隔套 Impeller sleeve	不锈钢 Stainless steel	AISI304
15	耐压筒 Cylinder	不锈钢 Stainless steel	AISI304
16	联轴器 Coupling	碳钢 Carbon steel	



# CDLF系列不锈钢立式多级泵 (CDLF)Vertical Multistage Centrifugal pump

## CDLF立式多级离心泵消防稳压泵性能范围 ( 2950rpm ) Performance Range of CDLF(2950rpm)

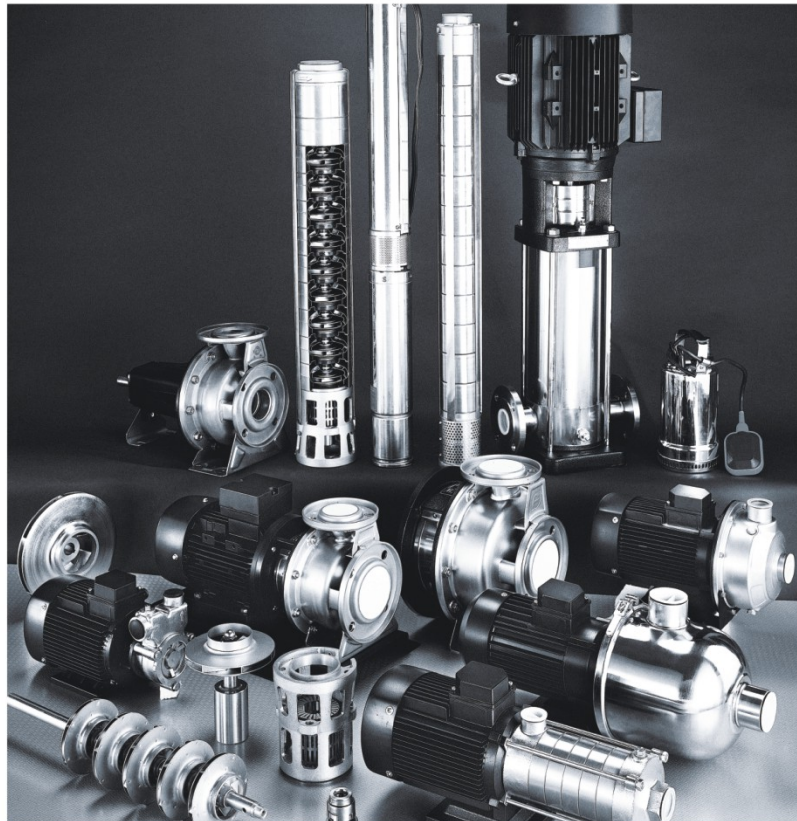
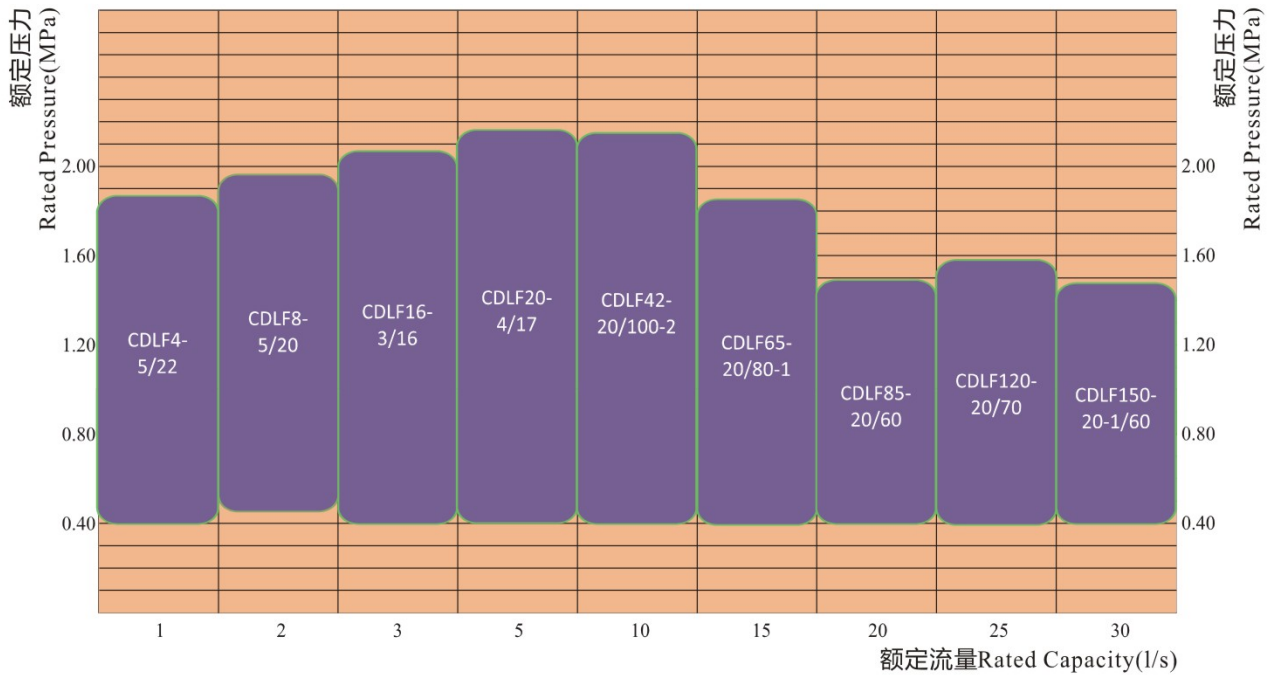



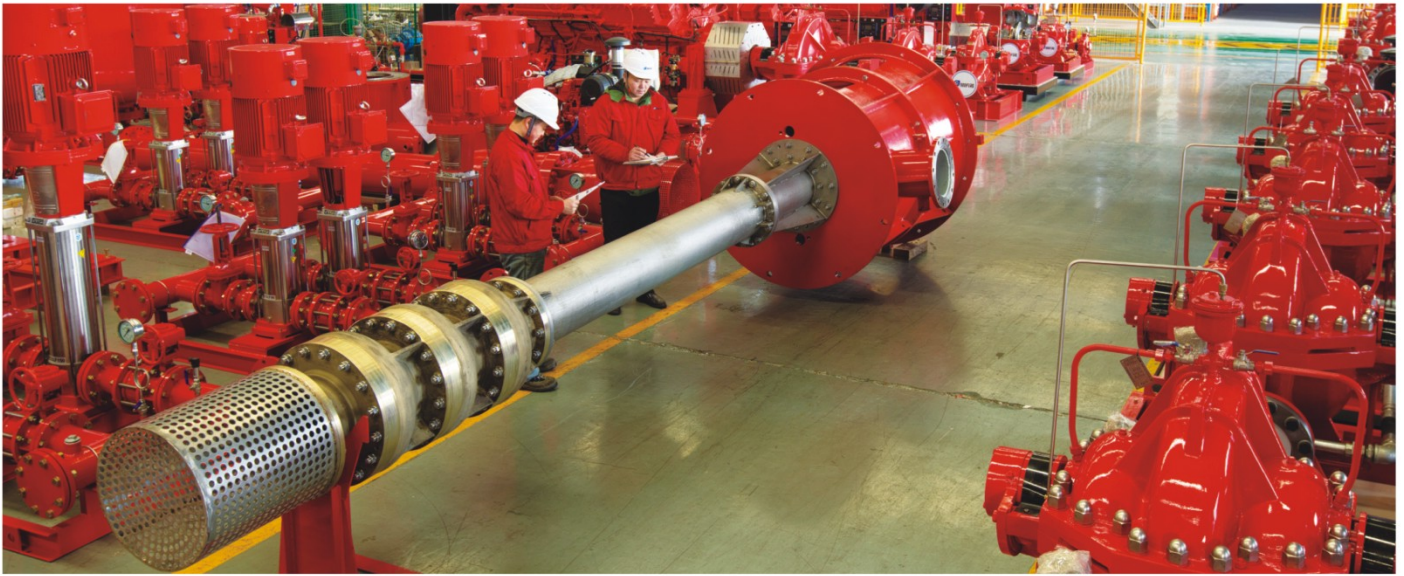



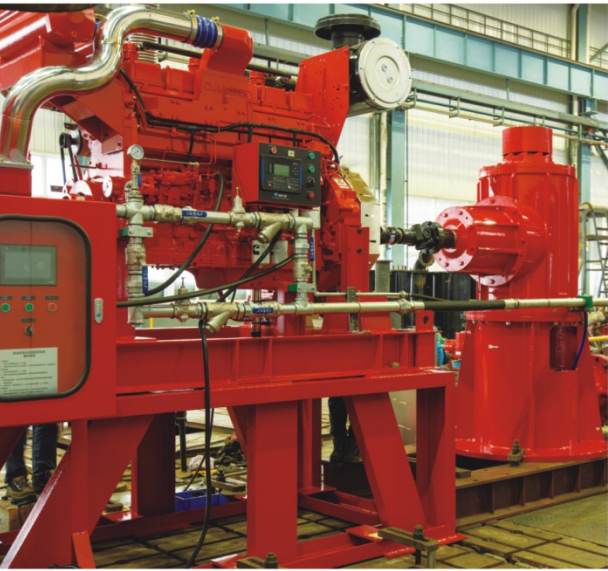











# 我们的客户

## Company Achievements



德国美力马公司  
MINIMAX



三星电子  
SAMSUNG



东方电气



美国亨氏公司  
HEINZ



美国伊顿公司  
EATON



美国辉瑞制药  
Pfizer



泰科国际有限公司  
TYCO



SINOMA



公安部上海消防研究所  
Shanghai Fire Research Institute of MPS





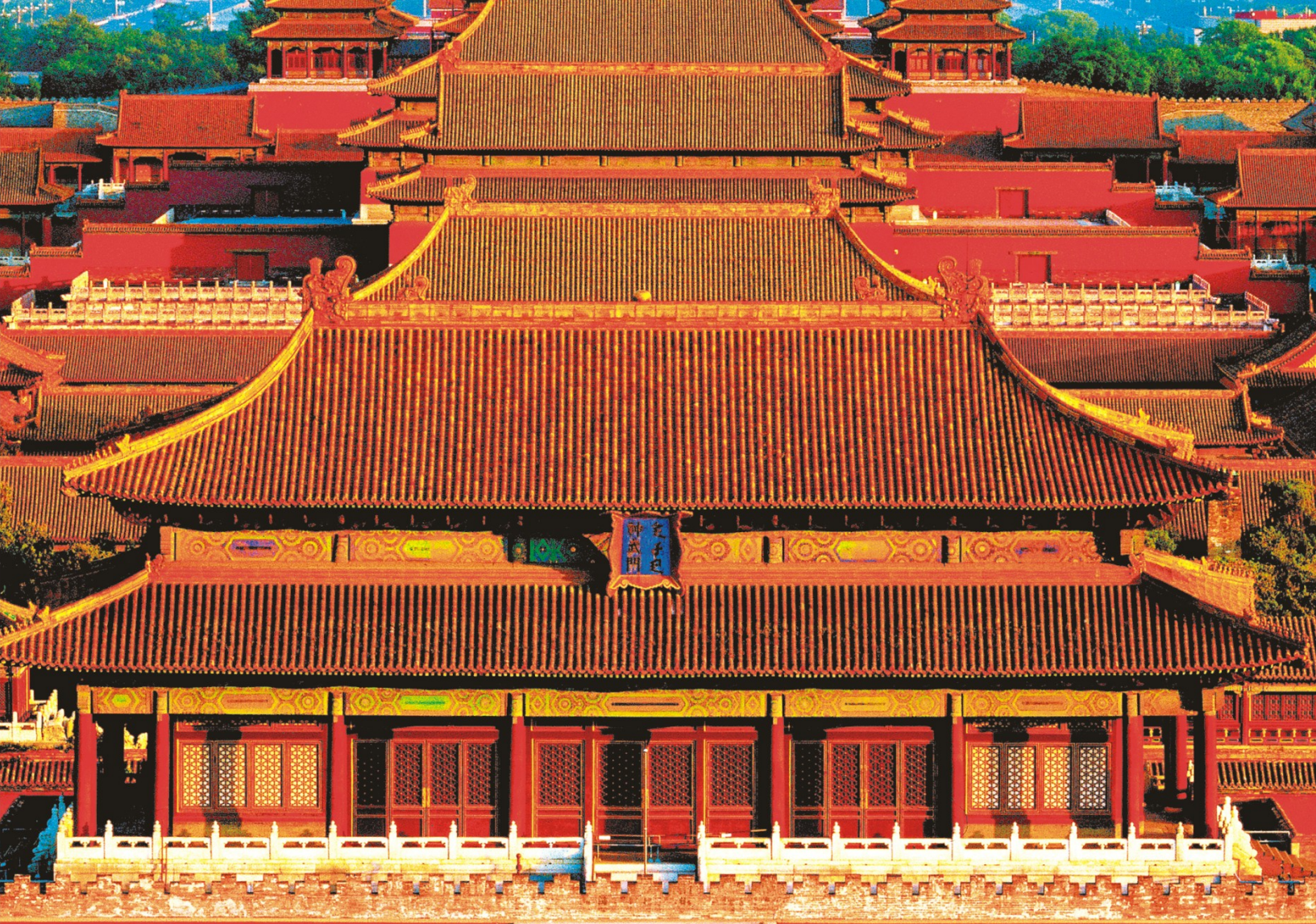

故宫博物院

New face Same dream

**NM FIRE**

**NM FIRE FIGHTING SYSTEM CO.,LTD**

Tel:+86-731-84091707

Web:nmfirepump.com

Email:nm-overseas@nanfang-pump.com

Add: No.45 Xi Chong Road,Quan Tang Street,Changsha ETDZ,Hunan,P.R.China





# 中国安美 安美中国

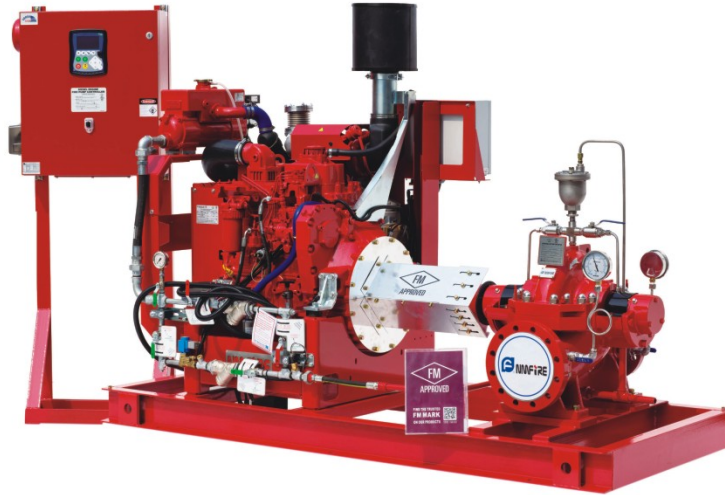

## 湖南南方安美消防设备有限公司

公司地址: 长沙经开区泉塘街道西冲路45号  
服务热线: +86-731-84091707  
邮箱: nm-domestic@nanfang-pump.com  
网址: www.nmfirepump.com

### NM Fire Malaysia

Add:18, Jalan 15/22, Taman Perindustrian Tiong Nam,  
Seksyen 15, 40200 Shah Alam, Selangor.  
Tel: 603-5524 6898  
FAX : 603-5524 6838  
MELUR GLOBAL SDN. BHD.  
EMAIL: sales@melurglobal.com

### NM Fire México S.de R.L.de C.V.

Valle de Guadalupe No.265-A  
Privadas de San Miguel,CP 67115,  
Guadalupe,Nuevo León,México  
Teléfono:+52 1(55)7761-7703  
Email:contacto@nmfiremexico.com

### NM Fire Singapore

Add: No. 2 Pioneer Sector 1, Singapore 628414  
Tel: +65 68611540  
Mobile: +65 97112935 (Bernard Yeo)  
Fax: +65 68611511  
Email: byeo@chemline.com.sg

### NM Fire Egypt

Add: 16 Naguib El Rihana Cairo  
Tel: +20 2 2591 3277  
Fax: +20 2 2590 0223  
Egyptian Engineering Agencies  
E-mail: kdayoub@eea-egypt.net

## CNP NM Fire Fighting System Co.,Ltd

Add.: No.45 Xi Chong Road, Quan Tang Street, Changsha  
ETDZ, Hunan, P.R. China  
Tel: +86-731-84091707  
Email: nm-overseas@nanfang-pump.com  
Web.: www.nmfirepump.com

### NM Fire -Africa

Add.: 13 Syringa Sands, Tugela Str , Glen Marais Kempton Park 1620  
Po Box 836, Glen Balad Mall, Kempton Park 1620  
Tel: 27 11 396 1115 / 27 82 315 1854(Jacques)  
Email:  
Renette : Accounts@nmfireafrica.com  
Jacques: Jacques@nmfireafrica.com  
Sales and Technical : Sales@nmfireafrica.com  
Web:www.nmfirepump.com

### NM Fire Brazil

Add: Rua João Roberto Thut, 495 - Bairro do Limão  
São Paulo-SP - CEP: 02751-010  
Tel: 113936.1544  
E-mail: igor@sipec.com.br

### NM Fire Indonesia

PT. ADITYA SARANA GRAHA  
Add.: Jl. Mampang Prapatan No.97,  
Jakarta Selatan 12790, Indonesia  
Tel : +62 21 7986588  
Fax : +62 21 7983675/6  
E-mail : nmfire.sales@aditya.co.id



欢迎扫描, 关注安美中国  
官方网站, 了解更多讯息 180529

数据仅供参考: 如有修改, 恕不通知。

版权所有, 盗版必究!